



XVH Series

Excess Flow Valves



XVH Series Excess Flow Valves act as flow switches that automatically close when a flow spike occurs, preventing uncontrolled release of system fluid. The XVH Series is available in automatic and manual reset versions, depending on system requirements. Automatic reset XVH Series have an “anti-clog” wire which increases reliability by preventing a build up of system fluid in the bleed port. The XVH Series are high pressure (0 to 6000 psig [414 bar]), high performance, quick acting, zero leakage, low maintenance excess flow valves that will help provide a reliable and safe working environment.

- Lower cost
- Versatile
- Reliable
- Safety
- Flexible

Features

Automatic reset

- The bleed vent allows the valve to automatically reset

Manual reset

- Zero leakage: the valve must be manually reset

2-piece design

- Allows for simple spring and seal maintenance

O-ring or metal seat

- Can be used with any liquid or gas service

Various body materials

- Can be used with any liquid or gas service

Various end connections

- Can be assembled in any system or application

Spring-loaded poppet

- Can be mounted in any orientation

Anti-clog wire

- Prevents clogging of bleed port

Technical Data

Body Material*	316 stainless steel, brass, Monel®, Hastelloy® C-276
Temperature Range	-320° to +900° F (-196° to +482° C)
Operating Pressure	Zero to 6000 psig (414 bar)
Leakage Rate	• External: zero leak • Internal soft seat: zero leak
Flow/Trip Point Ranges	Low, standard/low, medium, and high

* Consult factory for other materials

excess flow valves

HOKE Incorporated

405 Centura Court • PO Box 4866 (29305) • Spartanburg, SC 29303

Phone (864) 574-7966 Fax (864) 587-5608

www.hoke.com • sales@hoke.com

XVH Series

Function

Excess Flow Valves are designed to limit flow of fluid to a predetermined rate. When flow reaches a predetermined rate the poppet will close, limiting or stopping flow. When pressure is equalized across the valve, the poppet will reset to the open position.

Open Position

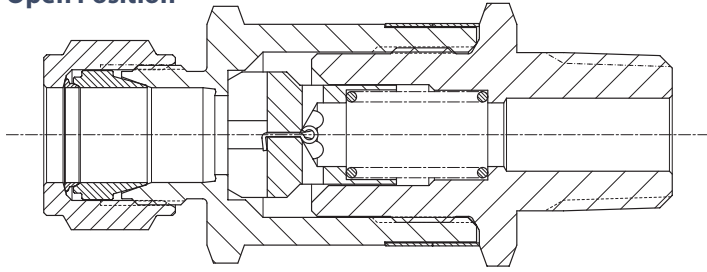

The spring holds the poppet in the open position during normal flow. When flow increases to the predetermined rate or trip point, the poppet will close.

Manual Reset

The poppet will remain in the tripped position with zero leakage and zero flow until pressure is manually equalized across the poppet. When the pressure becomes equal, the spring will then reset the poppet to the open position, allowing normal flow.

Tripped Position

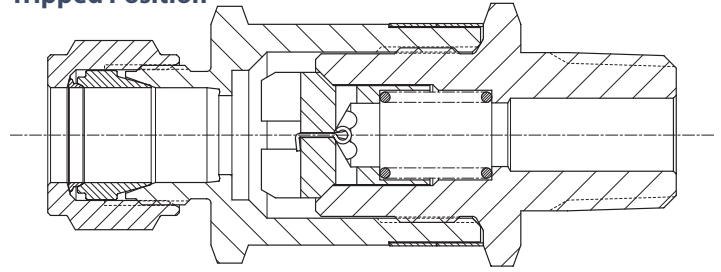

Automatic Reset

The poppet will remain in the tripped position until system pressure becomes equal across the poppet. The bleed orifice in the poppet will allow the pressure to slowly equalize across the valve if the downstream line is closed or repaired. When the pressure becomes equal, the spring will then reset the poppet to the open position, allowing normal flow.

Materials of Construction

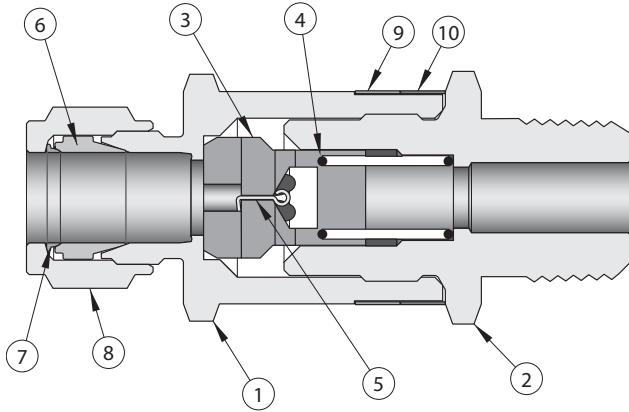

Part	Standard Material (others available on request)
1 Body* (outlet)	316 stainless steel
2 End adapter* (inlet)	316 stainless steel
3 Poppet*	316 stainless steel
4 Spring*	302 stainless steel or Inconel***
5 Anti-clog wire*	302 stainless steel
6 Front ferrule*	316 stainless steel
7 Rear ferrule	316 stainless steel
8 Nut	316 stainless steel
9 O-ring band	Anodized aluminum
10 Part number band	Anodized aluminum

* Wetted component

** Inconel® springs installed with (-25) Chemraz®, (-65) Kalrez®, and (-00) seals

Operating Temperatures

Soft Seal, Manual Reset Valve

O-ring Code	O-ring Material	Color	Temperature	
			°F	°C
-25	Chemraz®	Olive	-20° to +425°	-29° to +218°
-32	Viton®	Blue	-20° to +400°	-29° to +204°
-53	Neoprene	Red	-40° to +250°	-40° to +121°
-62	Ethylene propylene	Purple	-65° to +300°	-54° to +149°
-64	Fluorosilicone	Black	-80° to +350°	-62° to +177°
-65	Kalrez®	Olive	-40° to +550°	-40° to +288°
-77	Buna N	Green	-65° to +275°	-54° to +135°

Metal Seal, Automatic Reset Valve

O-ring Code	O-ring Material	Color	Temperature	
			°F	°C
-00	—	Gold	-320° to +900°	-196° to +482°



XVH Series

Trip Points/Ranges

XVH valves operate properly when they allow normal system flow and then close/trip at the increased flow rate. XVH series have 3 sizes of valves and 6 trip points/ranges per size. A valve is specified correctly when the trip point or trip range selected accommodates the application. The graphs below are flow curves that show trip points for liquids and trip ranges for gases. Liquid flow curves show specific flow rate trip points at specific pressure differentials. Gas flow curves show flow rate trip ranges at specific inlet pressures. Due to the compressive nature of gases, a minimum of 100 psid is required for gas applications.

Water Flow Rates: Low

Using the graphs below, look up your desired normal flow rate (including normal surges) on the X axis. Read vertically on the graph to the Cv line and then left on the graph from the Cv line to the pressure drop. Then select a valve and trip range higher than normal expected flow. For example: With a normal flow rate of 1010 cc/minute, a 1/4" valve (XVH-4) will have a pressure drop of approximately 1 psi. Selecting a 1/4" valve with a medium trip option, the valve will close when the flow reaches 1.5 GPM and a pressure drop of approximately 2.2 psi.

Water Flow – Low Inlet/Outlet Size = 1/4"

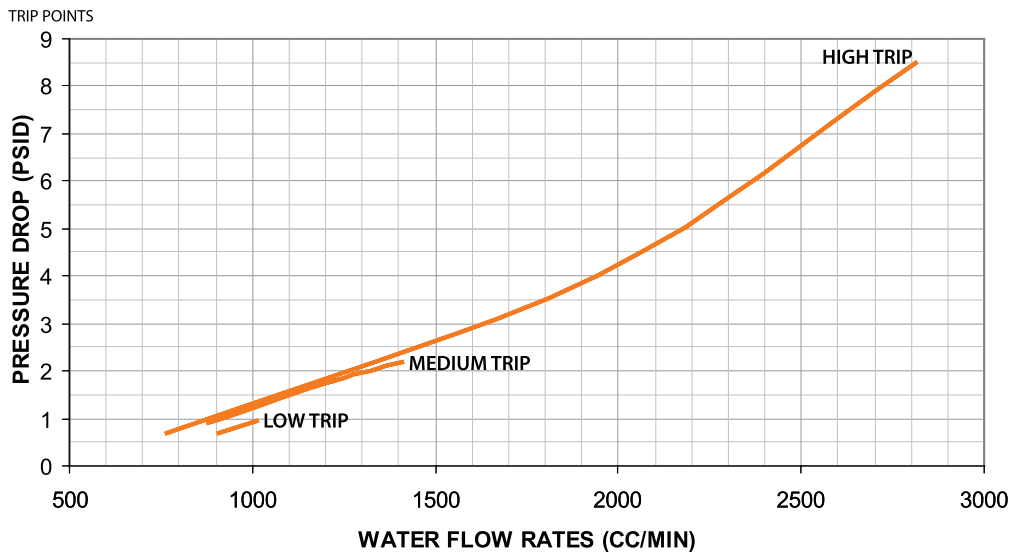

Water Flow – Low Inlet/Outlet Sizes = 3/8", 6mm

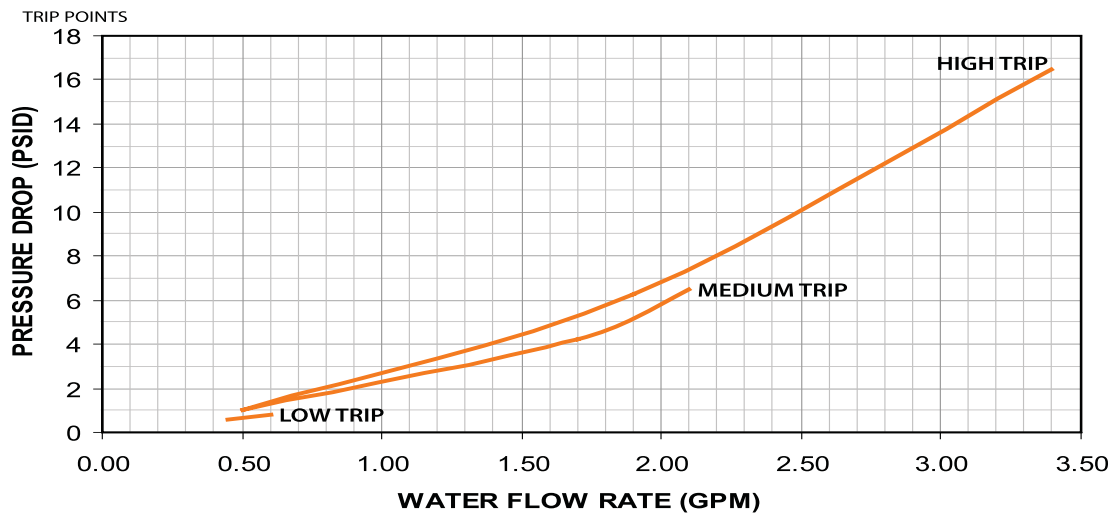

XVH Series

Water Flow – Low Inlet/Outlet Sizes = 1/2", 8mm

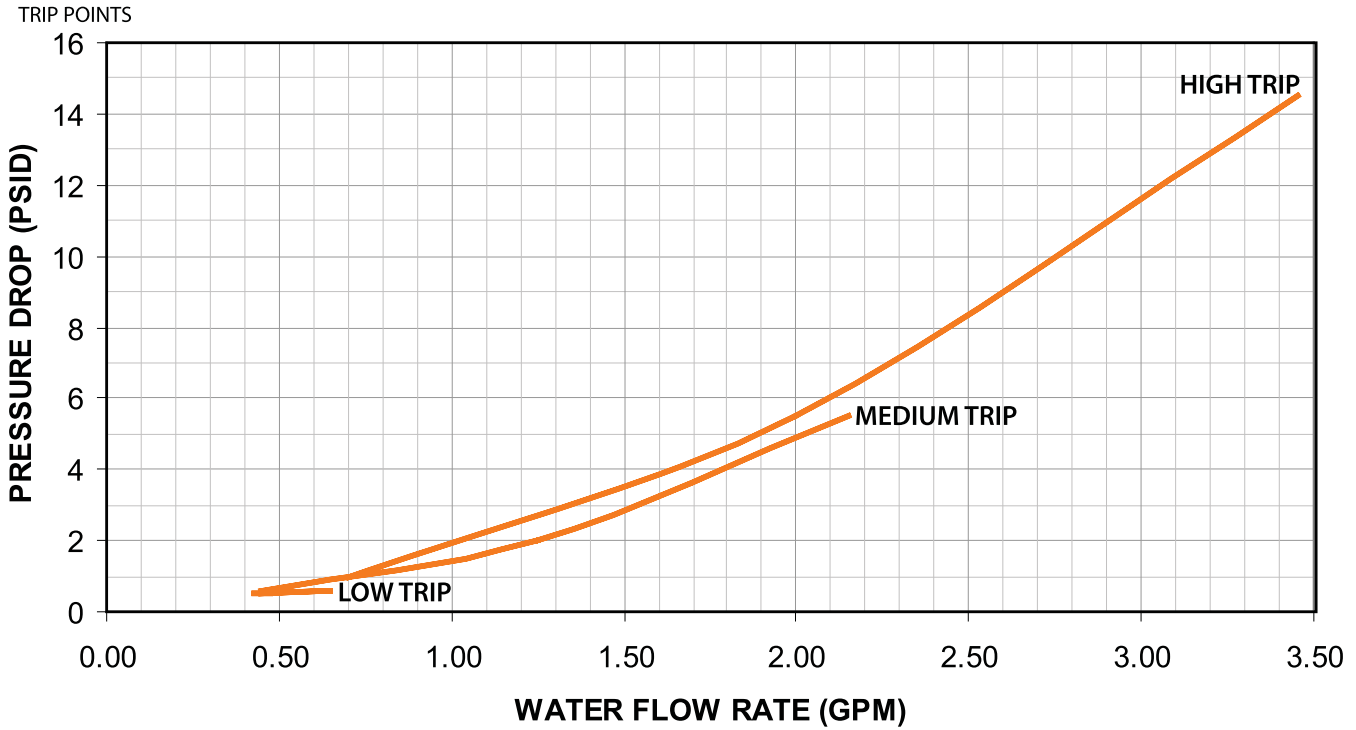

Air Flow Rates – Low

Using the graphs below, find the intersection of your normal flow rate (including normal surges) and the inlet pressure of the excess flow valve. From there, move to the right on the graph and select a valve with a trip range greater than your normal flow. For example: reading the chart below, if normal flow is 8 scfm and the inlet pressure is 400 psig, you would select a 1/4" valve with a high trip range.

Air Flow – Low Inlet/Outlet Size = 1/4"

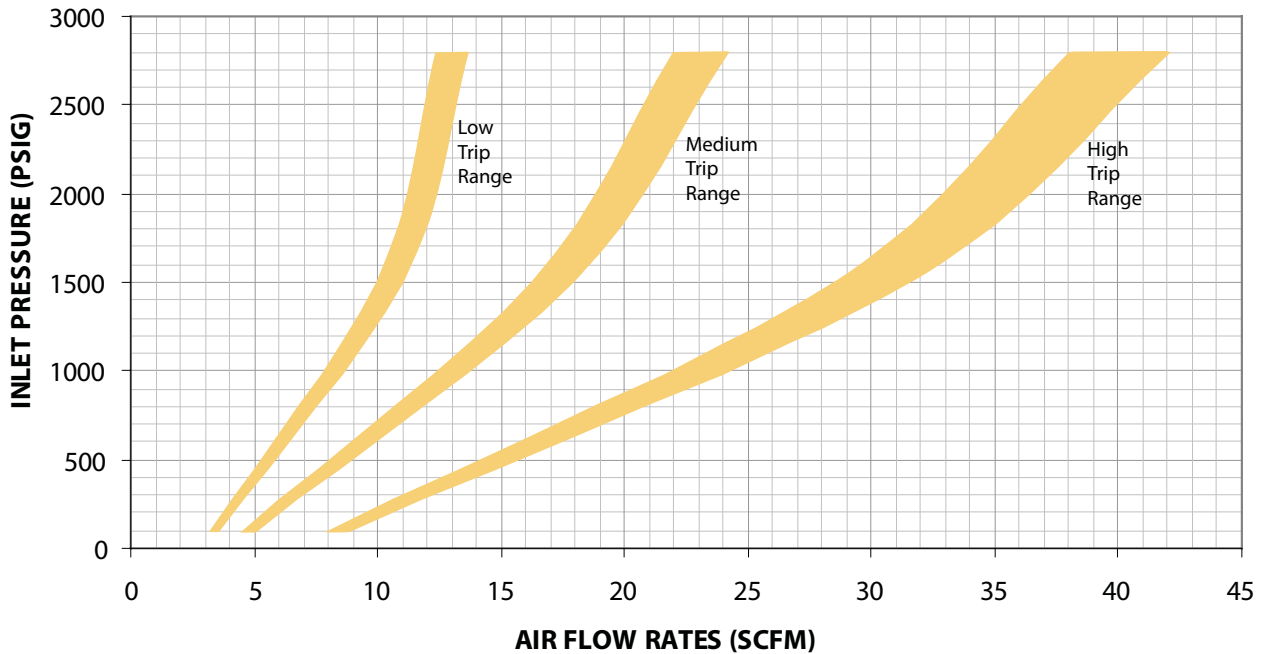

XVH Series

Air Flow – Low **Inlet/Outlet Sizes = 3/8", 6mm**

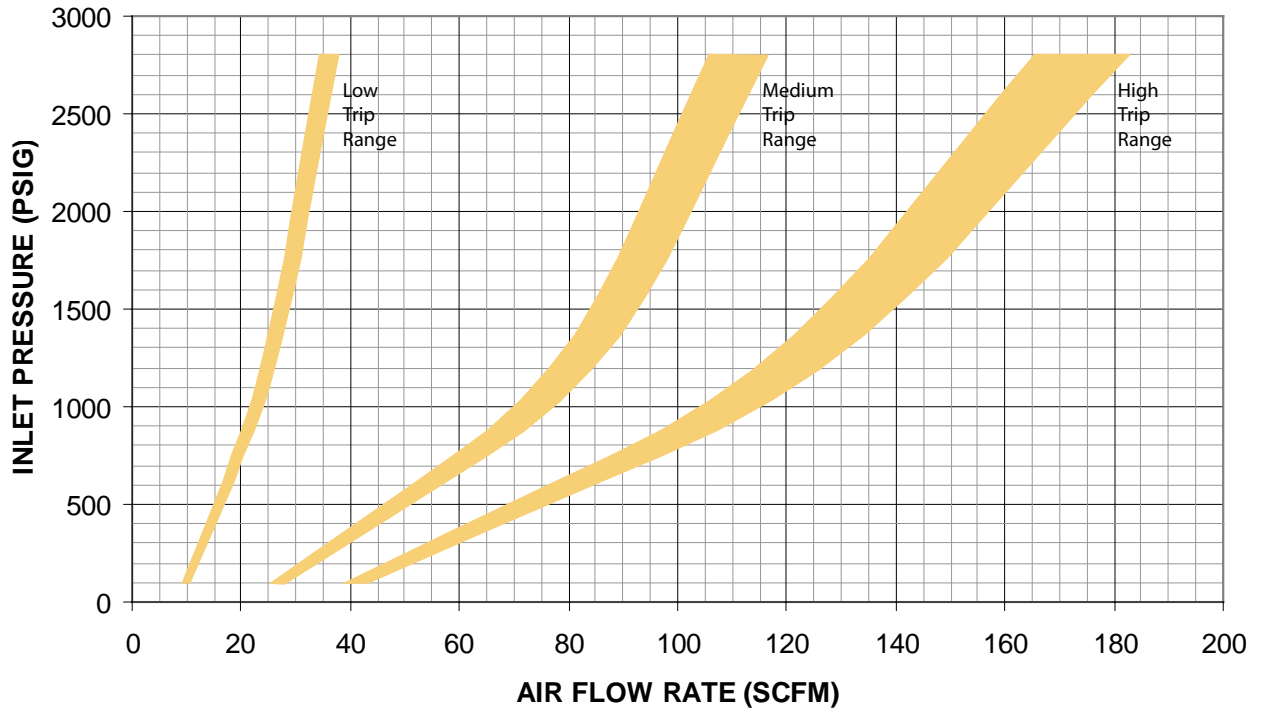

Air Flow – Low **Inlet/Outlet Sizes = 1/2", 8mm**

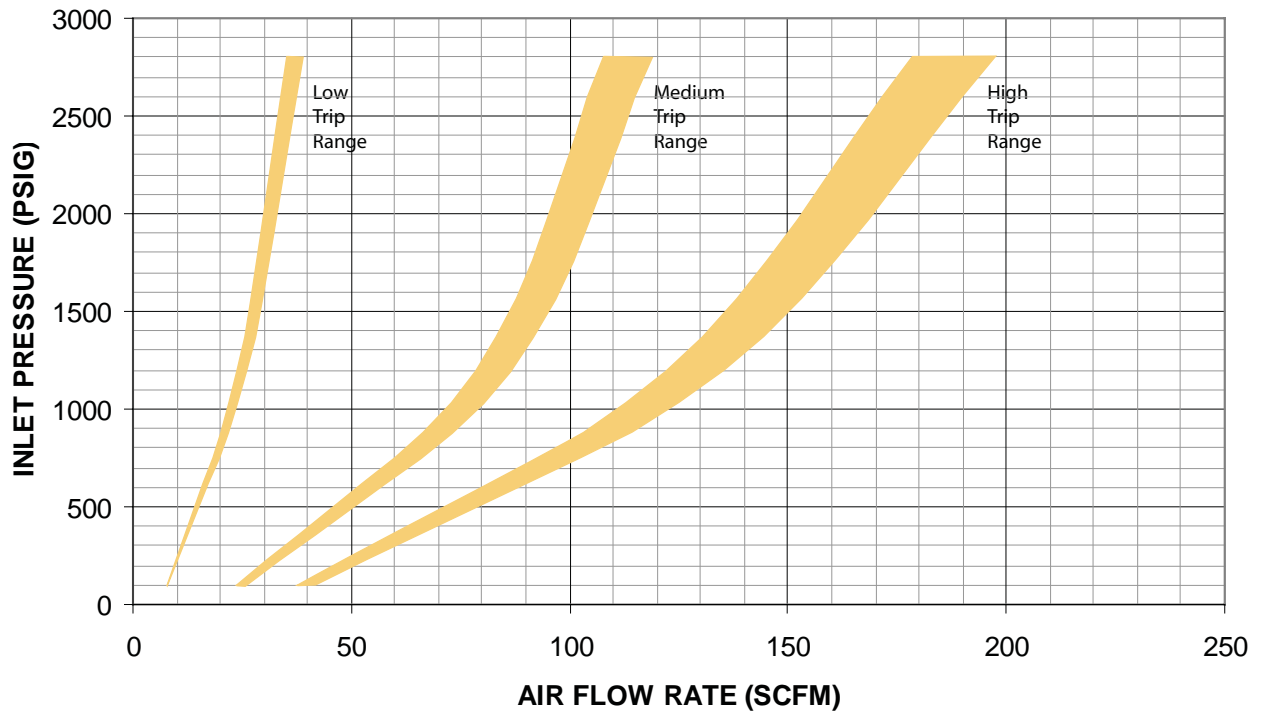

XVH Series

Water Flow Rates: Standard

Using the graph below, look up your desired normal flow rate (including normal surges) on the X axis. Read vertically on the graph to the Cv line and then left on the graph from the Cv line to the pressure drop. Then select a valve and trip range higher than normal expected flow. For example: With a normal flow rate of 1 GPM, a 1/4" valve (XVH-4) will have a pressure drop of approximately 6.5 psi. Selecting a 1/4" valve with a medium trip option, the valve will close when the flow reaches 1.5 GPM and a pressure drop of approximately 15 psi.

Water Flow – Standard Inlet/Outlet Sizes = 1/4", 3/8", 1/2", 6mm, 8mm

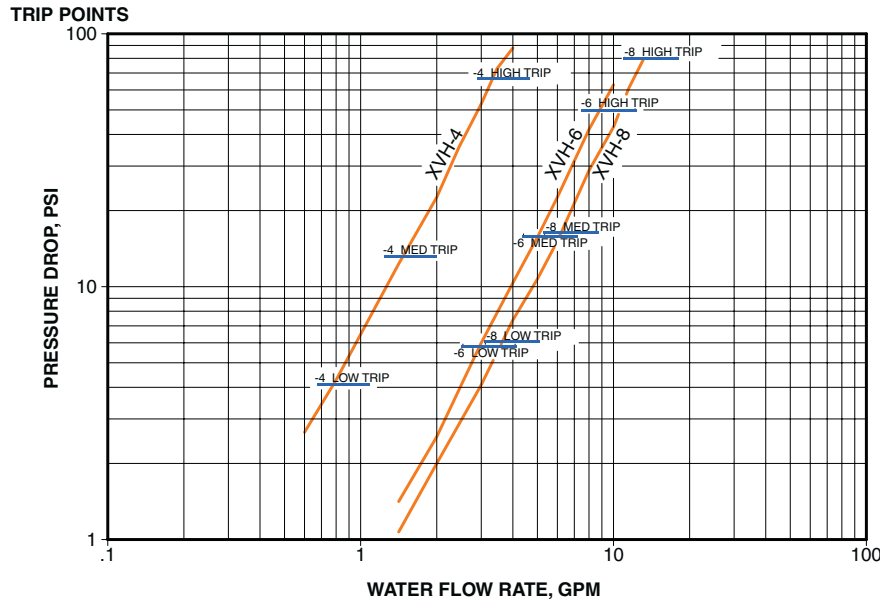

Note:
 XVH-4 is inlet/outlet size of 1/4"
 XVH-6 is inlet/outlet size of 3/8", 6mm
 XVH-8 is inlet/outlet size of 1/2", 8mm

Air Flow Rates – Standard

Using the graphs below, find the intersection of your normal flow rate (including normal surges) and the inlet pressure of the excess flow valve. From there, move to the right on the graph and select a valve with a trip range greater than your normal flow. For example: reading the chart below, if normal flow is 20 scfm and the inlet pressure is 200 psig, you would select a 1/4" valve with a medium trip range.

Air Flow – Standard Inlet/Outlet Sizes = 1/4", 6mm, 8mm

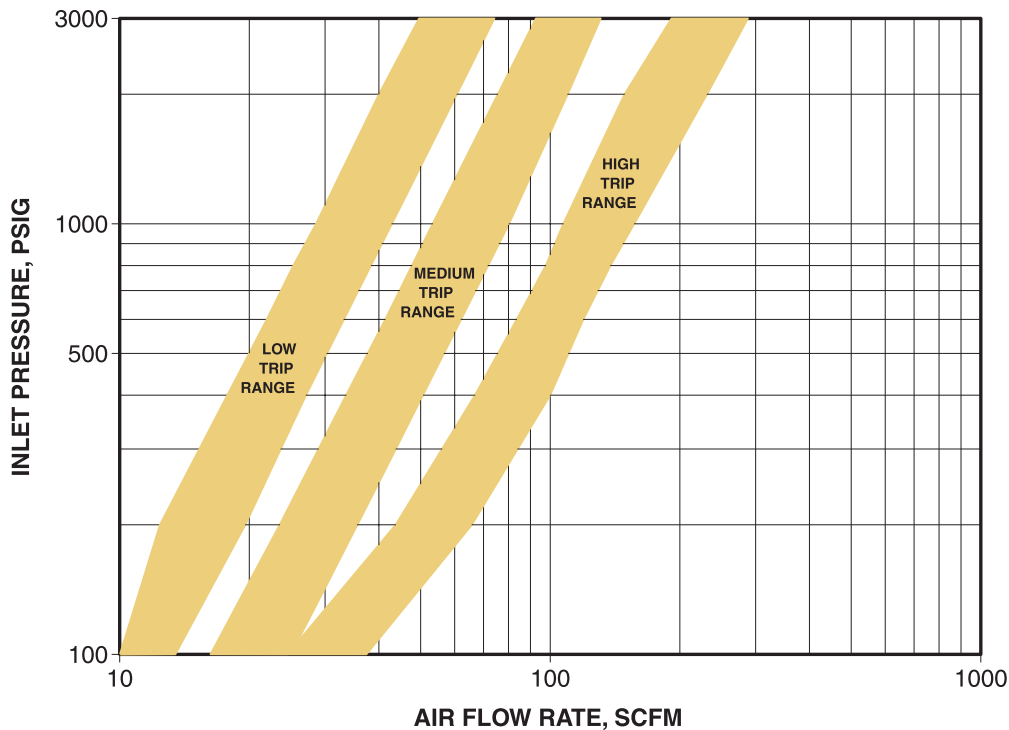

XVH Series

Air Flow –Standard Inlet/Outlet Sizes = $\frac{3}{8}$ " , 10mm, 12mm

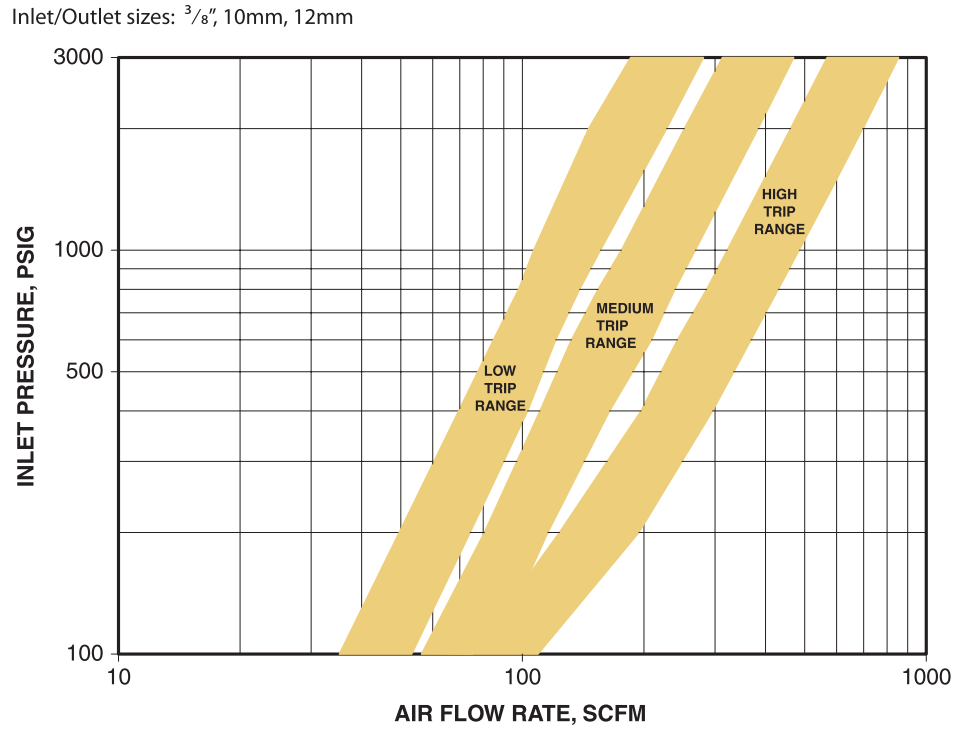

Air Flow –Standard Inlet/Outlet Sizes = $\frac{1}{2}$ " , 14mm

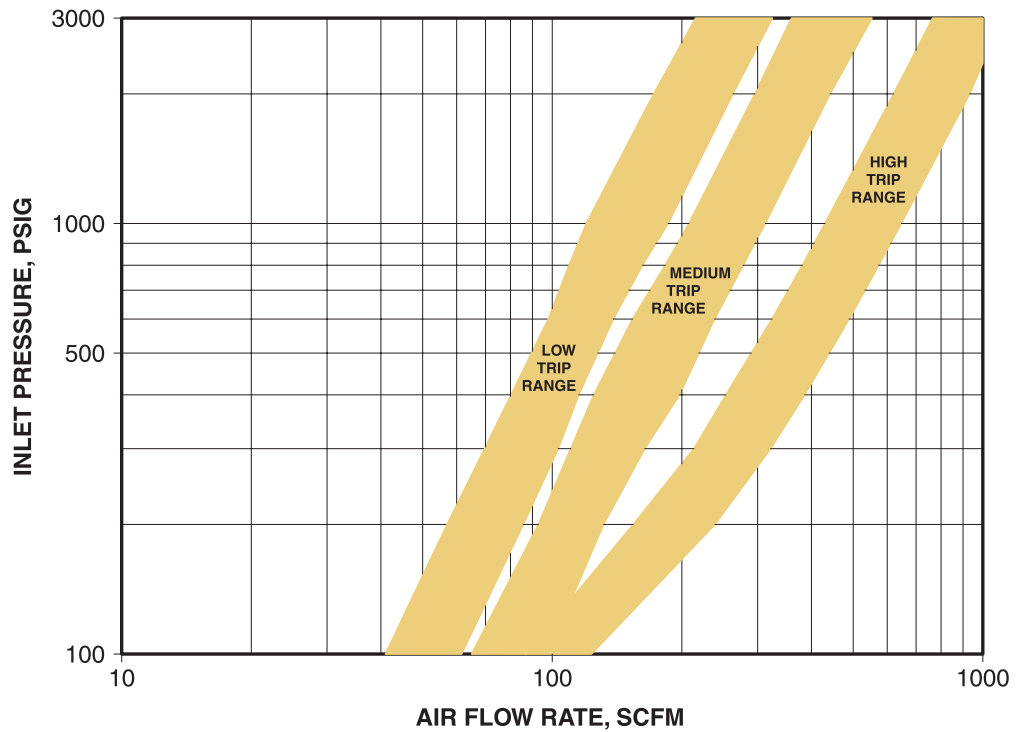

XVH Series

How to Order

Standard items in bold

XVH Y 08 M 08 G 00 100 A O H

BODY MATERIAL

- Y 316 stainless steel (standard)**
- B Brass
- M Monel®
- H Hastelloy® C-276

INLET SIZE

- 04 ¼" (standard)**
- 06 6mm, ⅜" (standard)**
- 08 8mm, ½" (standard)**
- 10 10mm
- 12 12mm
- 14 14mm

INLET STYLE

- G Gyrolok® tube fitting (standard)**
- A Gyrolok® tube adapter (standard)**
- Z Gyrolok® tube fitting, metric
- W Gyrolok® tube adapter, metric
- S Male SAE
- R Female SAE
- L Male British parallel pipe
- M Male NPT (standard)**
- F Female NPT (standard)**
- Q Male British tapered pipe
- P Female British tapered pipe

OUTLET SIZE

- 04 ¼" (standard)**
- 06 6mm, ⅜" (standard)**
- 08 8mm, ½" (standard)**
- 10 10mm
- 12 12mm
- 14 14mm

CLEANING OPTIONS

- 0 Standard**
- B Oxygen cleaning
- D NACE compliant

BAND OPTIONS

- A Standard**
- Y Corrosive atmosphere

TRIP POINT

- Standard Flow*
- 100 Low
- 200 Medium
- 300 High (standard)

Low Flow

- 010 Low
- 020 Medium
- 030 High

O-RING MATERIAL

- Automatic Reset*
- 00 No o-ring (metal-to-metal seat)

Manual Reset

- 25 Chemraz®
- 32 Viton®
- 53 Neoprene
- 62 Ethylene propylene
- 64 Fluorosilicone
- 65 Kalrez®
- 77 Buna N (not for oxygen service)

OUTLET STYLE

- G Gyrolok® tube fitting (standard)**
- A Gyrolok® tube adapter (standard)**
- Z Gyrolok® tube fitting, metric
- W Gyrolok® tube adapter, metric
- S Male SAE
- R Female SAE
- L Male British parallel pipe
- M Male NPT (standard)**
- F Female NPT (standard)**
- Q Male British tapered pipe
- P Female British tapered pipe

Note: Inlet and outlet fittings can be the same or mixed sizes and styles.

Gyrolok® is a registered trademark of HOKE Incorporated.

Monel® is a registered trademark of Special Metals Corporation.

Chemraz® is a registered trademark of Greene, Tweed & Co.

Kalrez® and Viton® are registered trademarks of DuPont Dow Elastomers.

Hastelloy® is a registered trademark of Haynes International, Inc.